

Standard & Armless (All 4 seat items ship as one piece if stationary, two pieces if motion installed)

2 Piece Curve Sectional & Ottomans

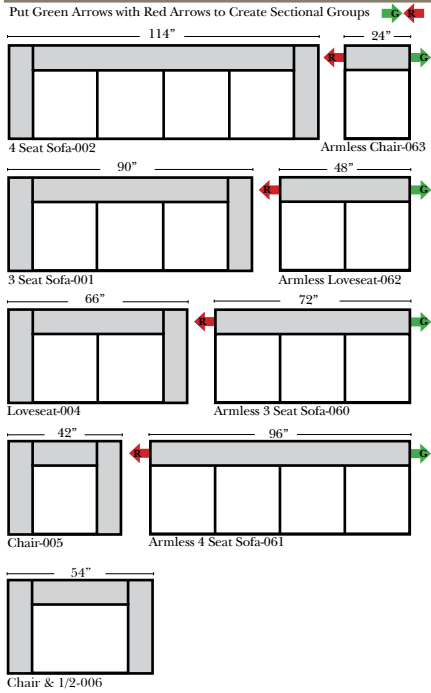

Put Blue Arrows with Yellow Arrows to Create Sectional Groups or Green Arrows with Red Arrows to mix with some of the L-Shaped pieces.

2 Piece Curve Sectionals
 for this style not available
 at this time

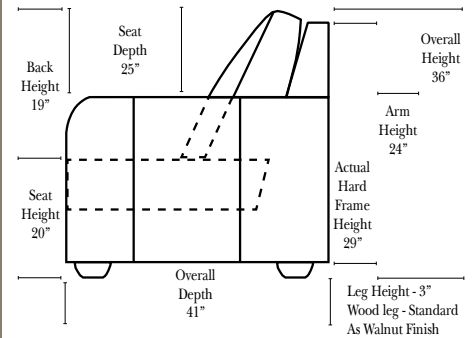
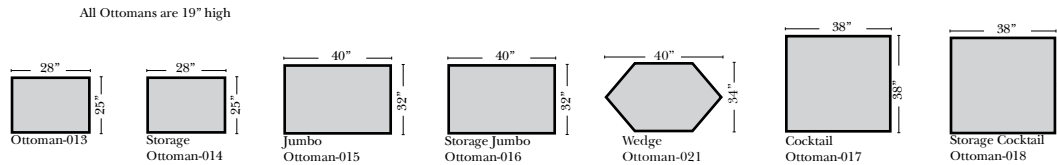

Features

Standard:

- Available in Full & Top Grain Leathers
- Available in Luxury Fabrics
- All Hardwood Frames
- Welting

Options:

- Down Seats & Down Backs (additional Charge)
- No. 33 Firm Foam
- Legs are standard as Walnut color, available in Cherry, Chocolate, Espresso, & Honey Oak

Sleeper Options: (All the below options are at additional charges)

- Queen Sleeper available w/Standard Mattress
- Twin Sleeper available w/Standard Mattress
- Deluxe Innerspring Mattress: Queen / Twin
- Air Dream Coil Mattress: Queen Only - (No Twin)
- Hideaway Air Mattress: Queen Only (Shipped in a Separate Box)

L-Shape / 90 Degree Sectional

(All 4 seat items ship as one piece if stationary, two pieces if motion installed)

Put Green Arrows with Red Arrows to Create Sectional Groups

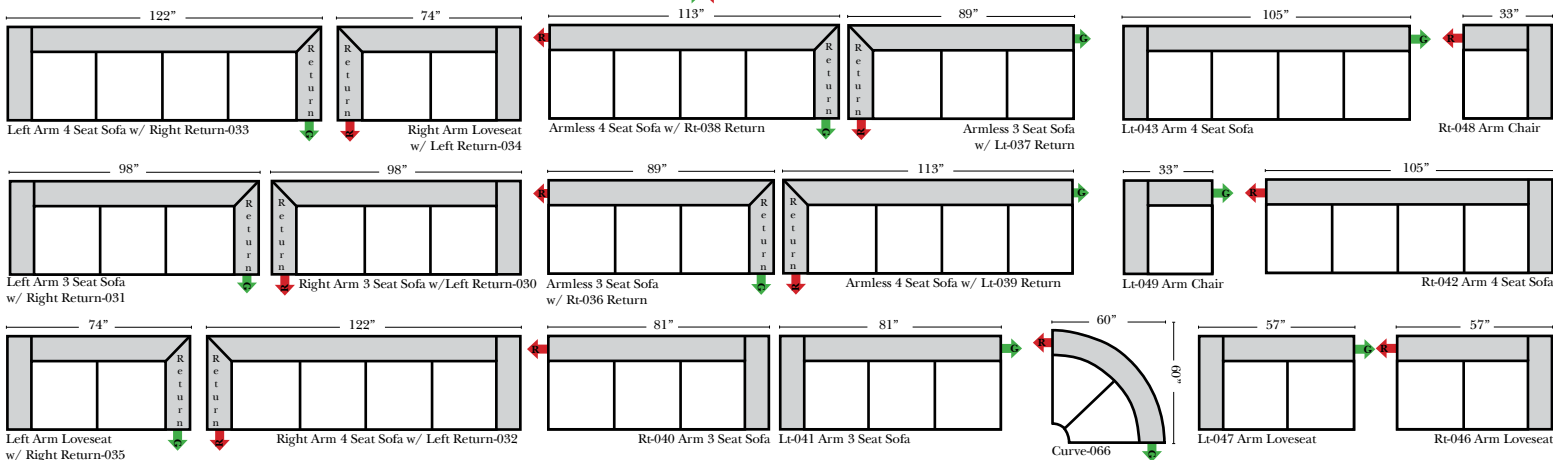

Note:

All Dimensions are approximate, if accuracy is crucial, please contact us for validation of the dimensions shown. However, a 1" to 2" variance can still apply due to foam and upholstery.



Chaise & Conversation Sectionals

Put Green Arrows with Red Arrows to Create Sectional Groups
Put Orange Arrows with Tan Arrows to Create Sectional Groups

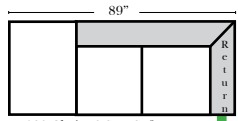

L1-093 Chaise 3 Seat Sofa w/ Opposite Return

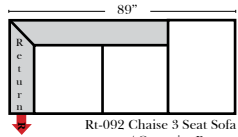

Rt-092 Chaise 3 Seat Sofa w/ Opposite Return

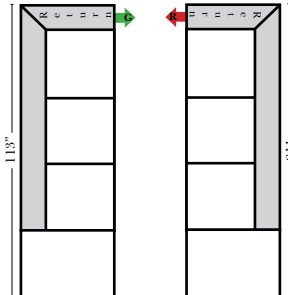

L1-095 Chaise 4 Seat Sofa w/ Opposite Return

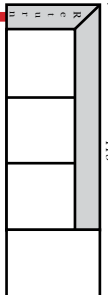

Rt-094 Chaise 4 Seat Sofa w/ Opposite Return

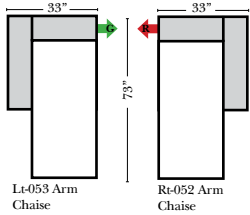

L1-053 Arm Chaise

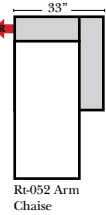

Rt-052 Arm Chaise

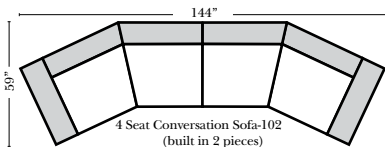

4 Seat Conversation Sofa-102 (built in 2 pieces)

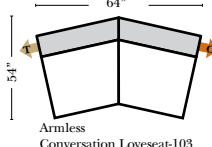

Armless Conversation Loveseat-103

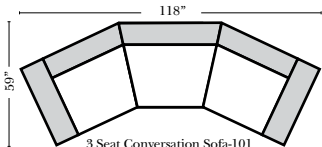

3 Seat Conversation Sofa-101

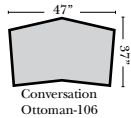

Conversation Ottoman-106

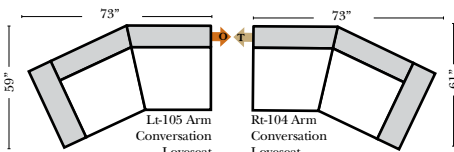

L1-105 Arm Conversation Loveseat

Rt-104 Arm Conversation Loveseat

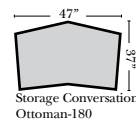

Storage Conversation Ottoman-180

Sleepers

Put Green Arrows with Red Arrows to Create Sectional Groups
Put Blue Arrows with Yellow Arrows to Create Sectional Groups

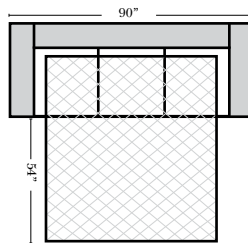

Q-127 Queen Sleeper

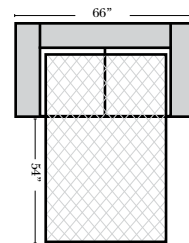

T-125 Twin Sleeper

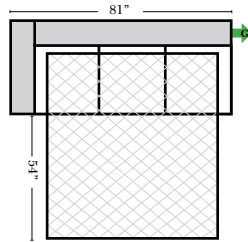

Lt Arm Queen Sleeper-QL-131

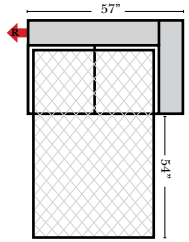

Rt Arm Twin Sleeper-TR-132

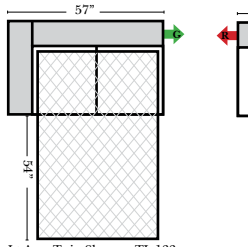

Lt Arm Twin Sleeper-TL-133

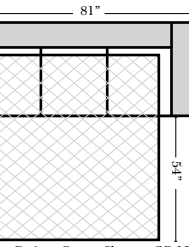

Rt Arm Queen Sleeper-QR-130

Suggested Configurations

07/06/2012

The Suggested Configurations below are only a sample of what the imagination can create, please enjoy creating the configuration that fits your lifestyle, using the ideas below and from the items on the opposite page.

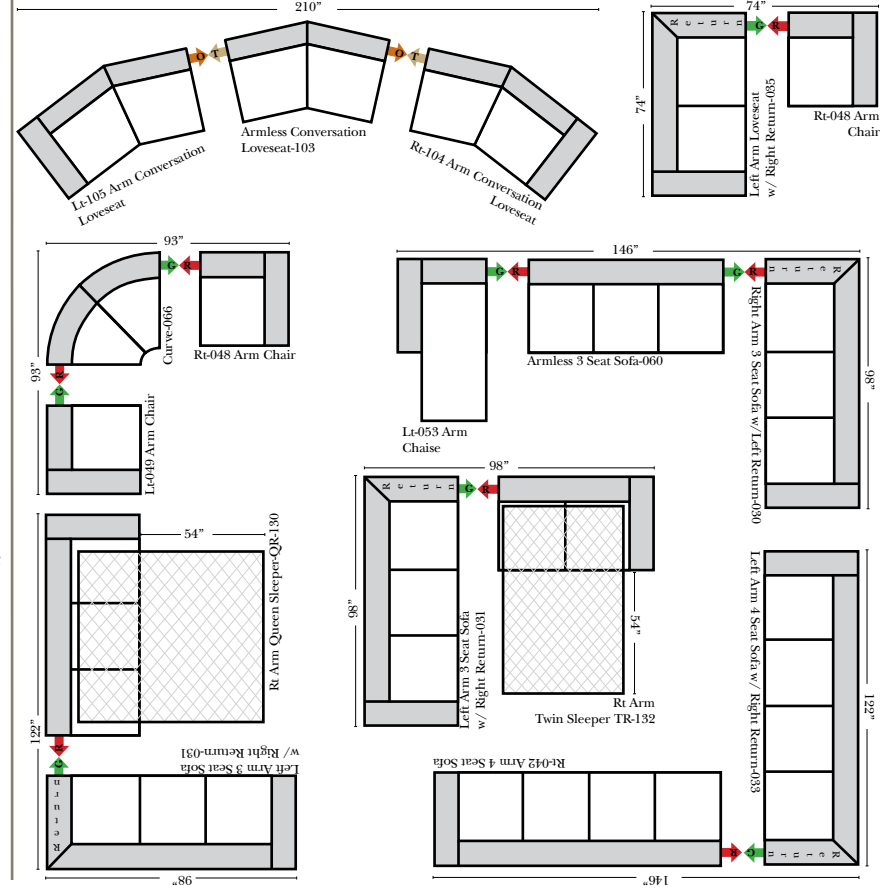

Sleepers (Cont.)