

Standard & Armless (All 4 seat items ship as one piece if stationary, two pieces if motion installed)

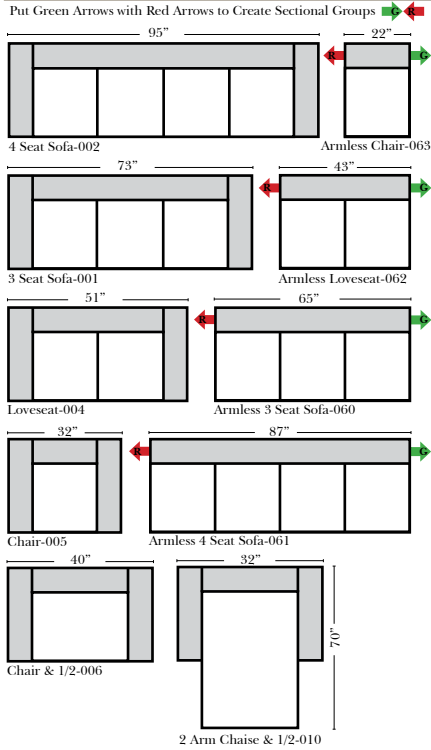

2 Piece Curve Sectional & Ottomans

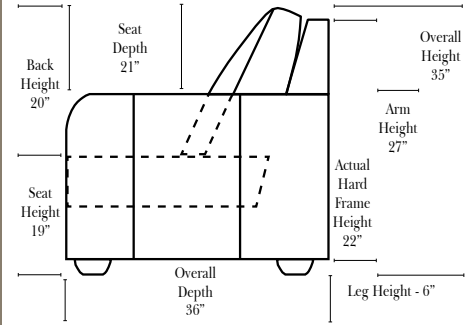
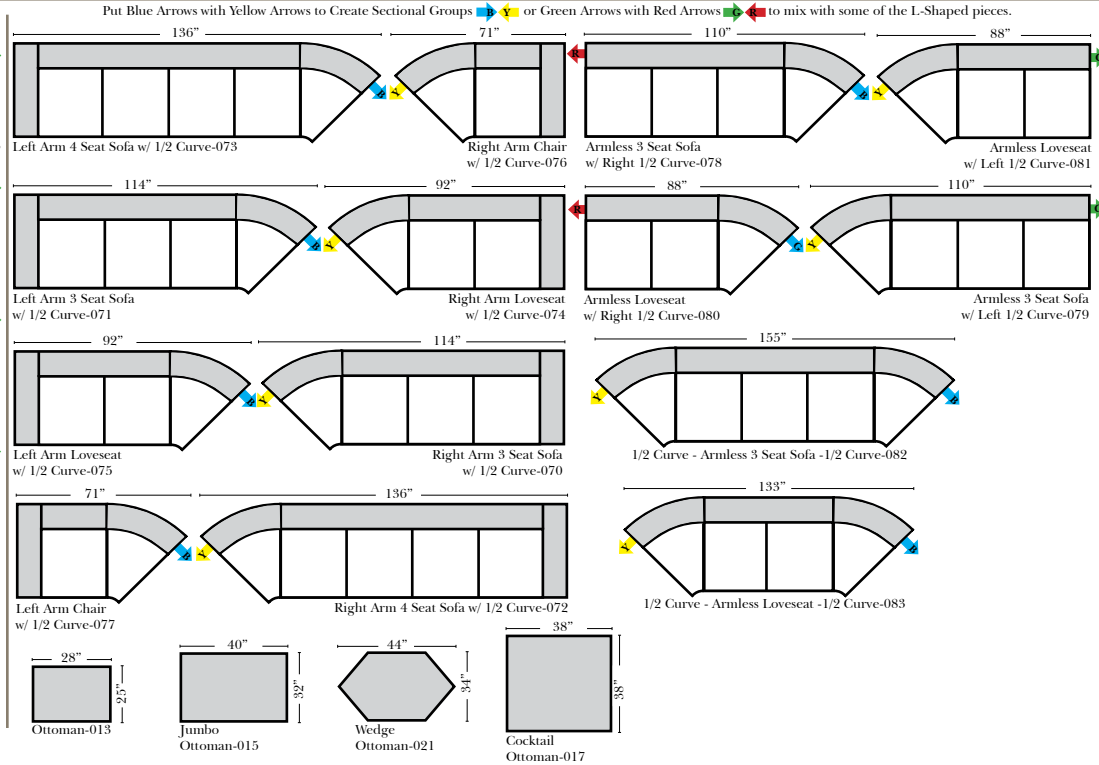

Features

Standard:

- Available in Full & Top Grain Leathers
- Available in Luxury Fabrics
- All Hardwood Frames

Options:

- Down Seats & Down Backs (additional Charge)
- No. 33 Firm Foam

Sleeper Options: (No Sleepers available for this style)

L-Shape / 90 Degree Sectional

(All 4 seat items ship as one piece if stationary, two pieces if motion installed)

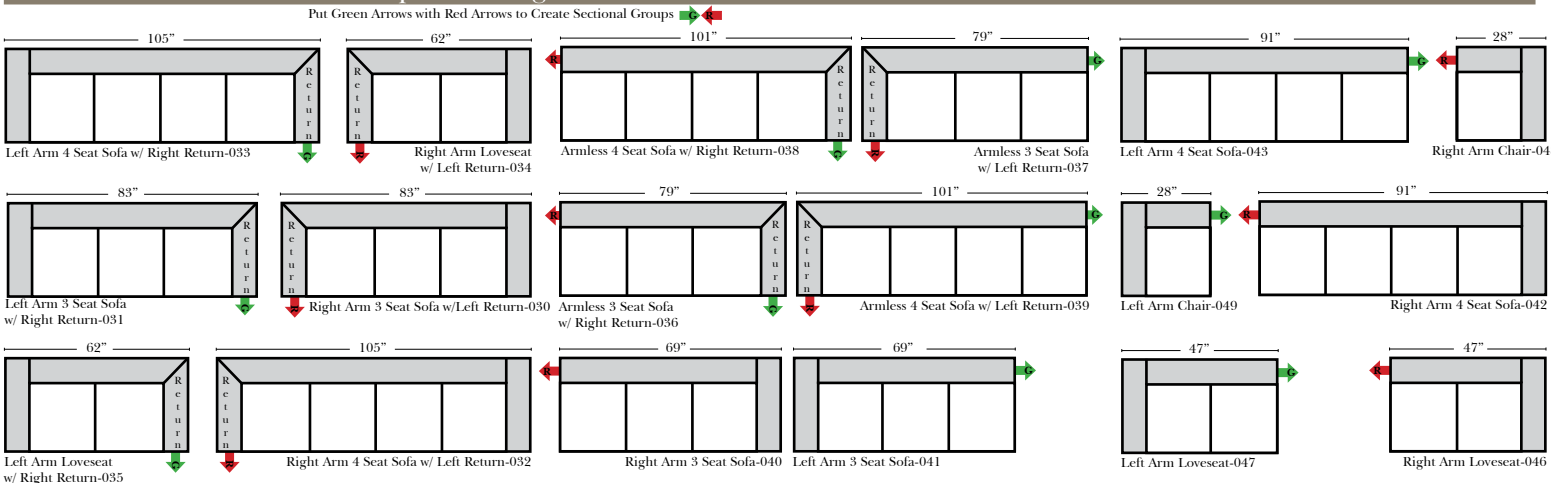

Note:

All Dimensions are approximate, if accuracy is crucial, please contact us for validation of the dimensions shown. However, a 1" to 2" variance can still apply due to foam and upholstery.



Chaise & Conversation Sectionals

Put Green Arrows with Red Arrows to Create Sectional Groups
Put Orange Arrows with Tan Arrows to Create Sectional Groups

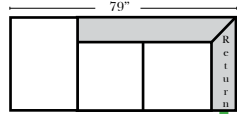

Left Chaise 3 Seat Sofa w/ Right Return-093

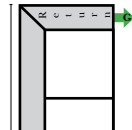

Left Chaise 4 Seat Sofa w/ Right Return-095

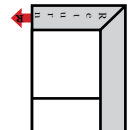

Right Chaise 4 Seat Sofa w/ Left Return-094

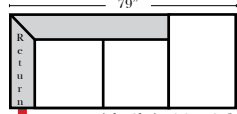

Right Chaise 3 Seat Sofa w/ Left Return-092

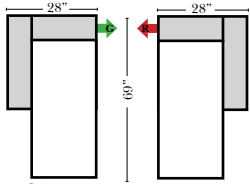

Left Arm Chaise-053

Right Arm Chaise-052

Conversation Sectionals
for this style not available
at this time

Sleepers

Put Green Arrows with Red Arrows to Create Sectional Groups
Put Blue Arrows with Yellow Arrows to Create Sectional Groups

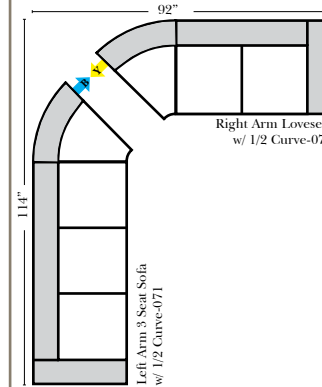
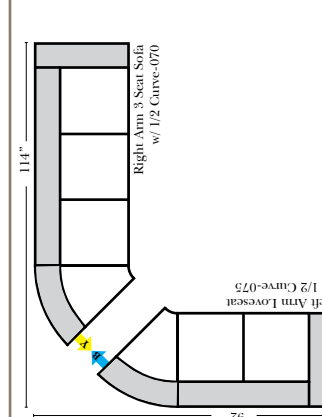

Sleepers
for this style not available
at this time

Suggested Configurations

07/06/2012

The Suggested Configurations below are only a sample of what the imagination can create, please enjoy creating the configuration that fits your lifestyle, using the ideas below and from the items on the opposite page.

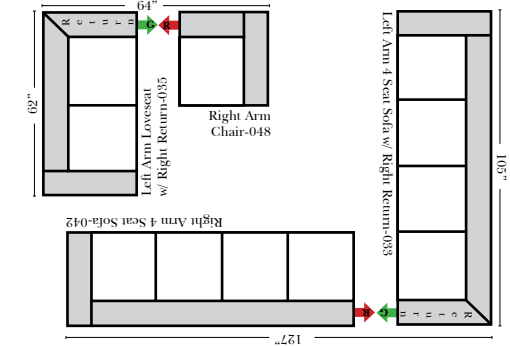
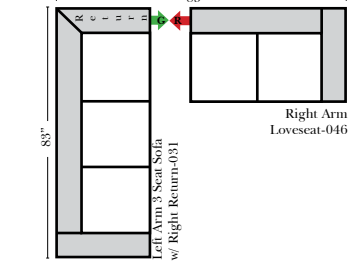
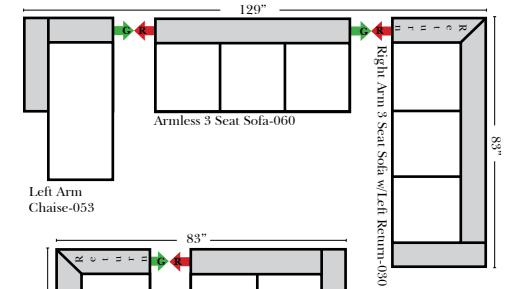

Sleepers (Cont.)