

M-T[SV]

# Sierra Vista

(Tall)

CUSTOMER:

DATE: P.O.

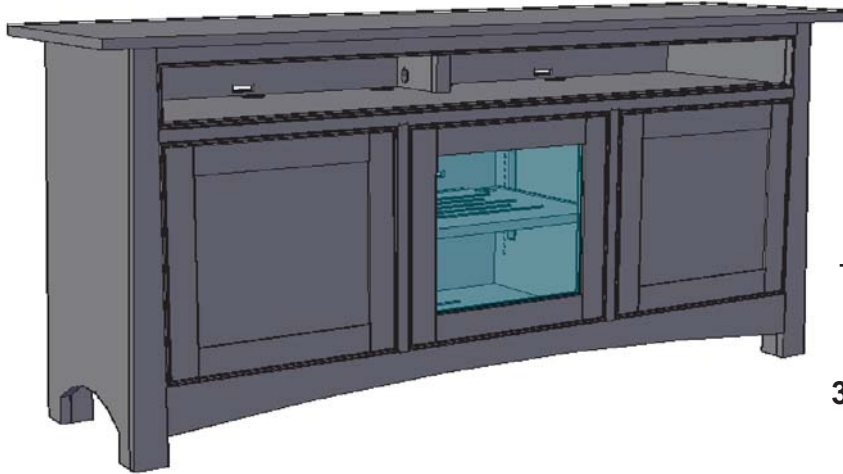

- 62" M-62T[SV]
- 66" M-66T[SV]
- 70" M-70T[SV]

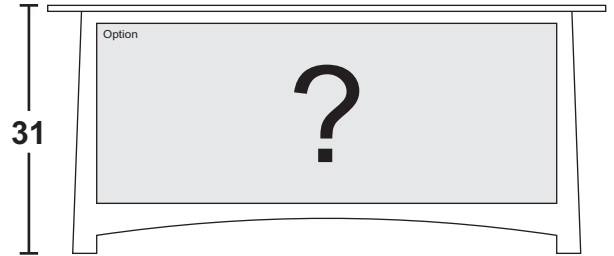

C1

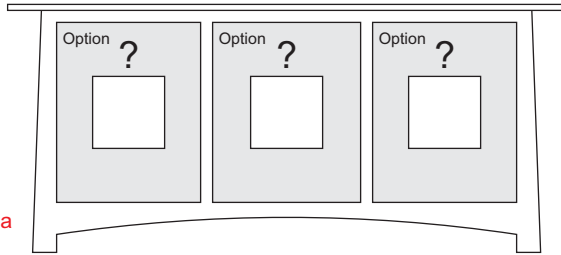

Non Media Cabinet

**Option Selections:**

(Write selection on WHITE / GREY boxes)

<b>D</b>	<b>G</b>	<b>K</b>	<b>R</b>	<b>M</b>
Wood Door w/ 1 adj sh	Glass Door w/ 1 adj sh	SPK Door w/ 1 adj sh	2 - Drawer	1 - Drawer w/ SPK Drop-Door

**Option Selections:**

Write selection on WHITE/GREY boxes

C2

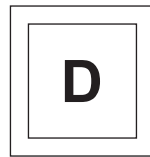
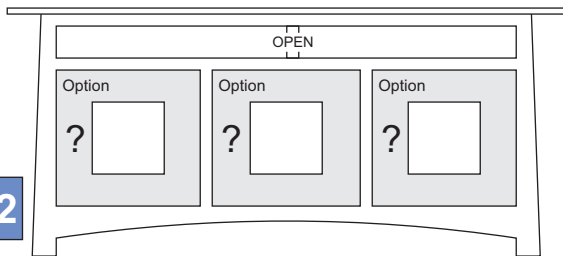

Wood Door  
w/ 1 adj sh



Glass Door  
w/ 1 adj sh

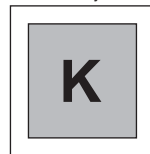

SPK Door  
w/ 1 adj sh

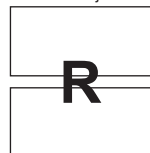

2 - Drawer

**Wood Selection**

**FINISH**

**HARDWARE**

DOOR DRAWER

**ADDITIONAL SHELF**

QTY

C3

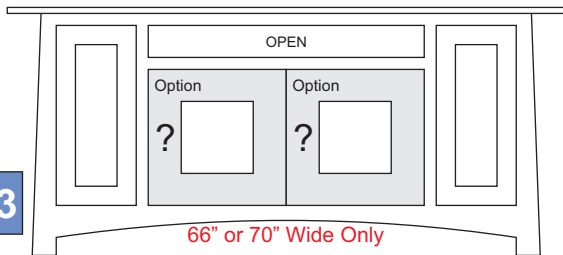

C4

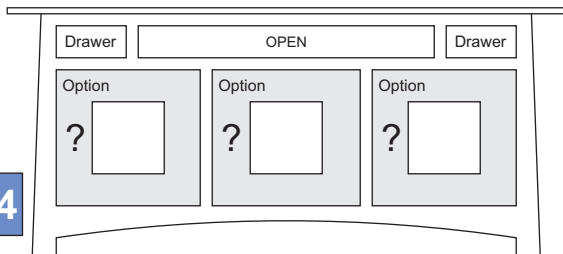

# M-T[SV]

## SPECIFICATIONS

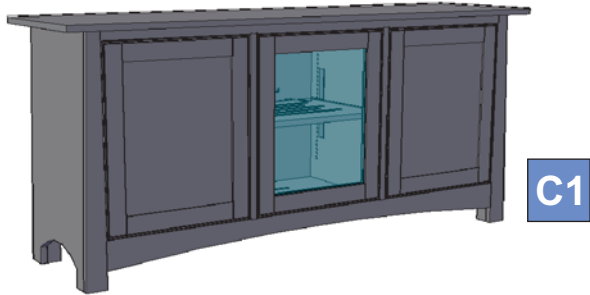

C1

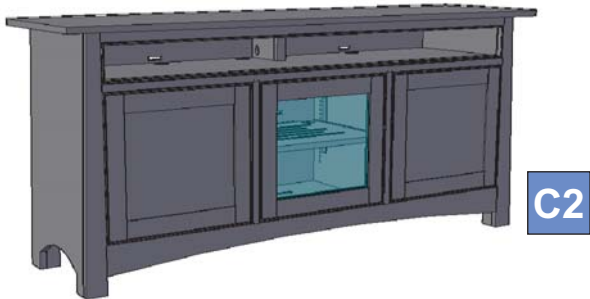

C2

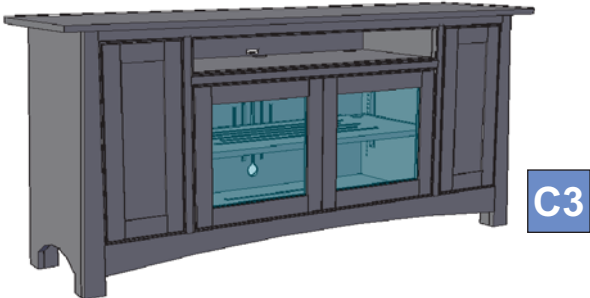

C3

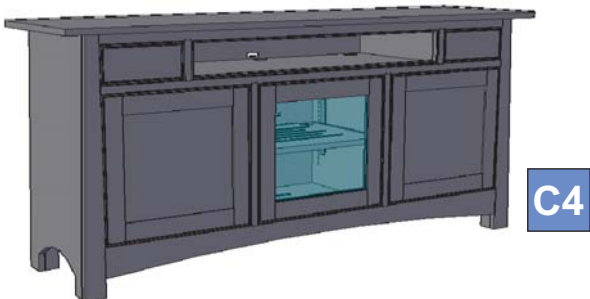

C4

### Featuring:

- Excellent ventilation in the console floor, backs and shelves.
- Smart holes & cut-outs for easy wire management throughout.
- Three prong power harness.
- Adjustable, VENTED shelves.

### Sizing Info

CONSOLE DATA: [SV] [TALL]			
	UNIT 62	UNIT 66	UNIT 70
Width	62	66	70
Width (OA) (TOP)	65.75	69.75	73.75
Width (OA) BASE-MOLDING (APPROX)	62	66	66
Height	31	31	31
Depth (OA) (TOP)	19	19	19
Depth (OA) BASE-MOLDING (APPROX)	17.5	17.5	17.5
Depth (inside)	16.1875		
[C1] Horz Space (L/R)	17.6875	19	20.3125
[C1] Horz Space (M)	17.625	19	20.375
[C1] Vert Space (Door)	22.5	22.5	22.5
[C1] Vert Space (MSK)	6.5	6.5	6.5
[C1] Drawer Width (inside) (L/R)	15.625	16.9375	18.25
[C1] Drawer Width (inside) (M)	15.5625	16.9375	18.3125
[C1] Drawer Height (inside) (approx)	5	5	5
[C2] Horz Space (L/R)	17.6875	19	20.3125
[C2] Horz Space (M)	17.625	19	20.375
[C2] Vert Space (Door)	17	17	17
[C2] Vert Space (Open/Top)	4	4	4
[C2] Horz Space (Open/Top)	56	60	64
[C2] Drawer Width (inside) (L/R)	15.625	16.9375	18.25
[C2] Drawer Width (inside) (M)	15.5625	16.9375	18.3125
[C2] Drawer Height (inside) (approx)	6	6	6
[C3] Horz Space (SoundBar)		37	37
[C3] Horz Space (media)		37	37
[C3] Horz Space (L/R)		13	15
[C3] Vert Space (SoundBar)		4	4
[C3] Vert Space (media)		17	17
[C3] Vert Space (L/R)		22.5	22.5
[C3] SoundBar Depth		6	6
[C3] Drawer Width (inside)		7.9375	9.9375
[C3] Drawer Height (inside) (approx)		6	6
[C4] Horz Space (L/R)	17.6875	19	20.3125
[C4] Horz Space (M)	17.625	19	20.375
[C4] Vert Space (Door)	17	17	17
[C4] Vert Space (Open/Top)	4	4	4
[C4] Horz Space (Open/Top)	37	37	37
[C4] Drawer Width (inside) (approx)(L/R-top)	5.9375	7.9375	9.9375
[C4] Drawer Height (inside) (approx)(top)	2	2	2
[C4] Drawer Height (inside) (approx)	6	6	6
Drawer Depth (inside)	15	15	15

\*Non-Media C1: All Depths -2"

Upon request, we will change the horizontal values (A & B & C) as well as speaker area sizing for no additional charge.

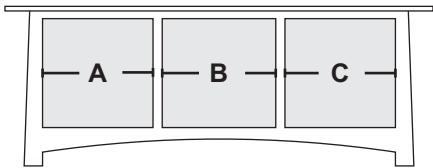

The CONSOLE (width, depth & height) may also be REDUCED (gratis). Further modifications may be requested via quote.

**M-[SV]**

# Sierra Vista (Short)

CUSTOMER: \_\_\_\_\_  
 DATE: \_\_\_\_\_ P.O. \_\_\_\_\_

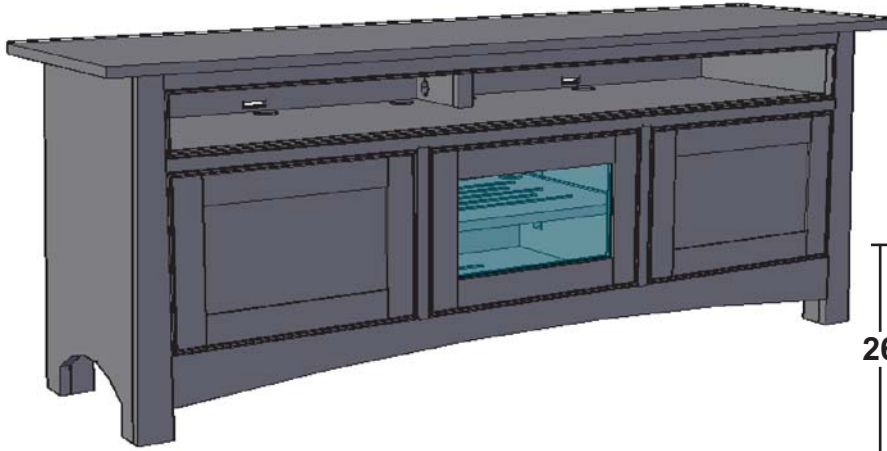

62" M-62[SV]  
 66" M-66[SV]  
 70" M-70[SV]

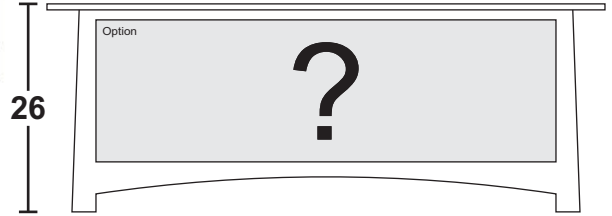

**C1**

Non Media Cabinet

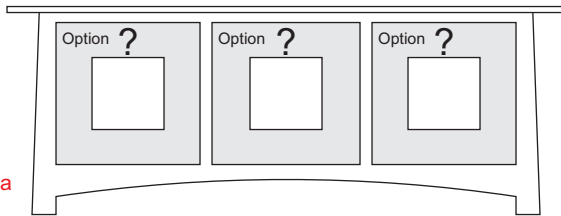

**Option Selections:**  
(Write selection on WHITE / GREY boxes)

<b>D</b>	<b>G</b>	<b>K</b>	<b>R</b>	<b>M</b>
Wood Door w/ 1 adj sh	Glass Door w/ 1 adj sh	SPK Door w/ 1 adj sh	2 - Drawer	1 - Drawer w/ SPK Drop-Door

**Option Selections:**  
Write selection on  
WHITE/GREY boxes

**C2**

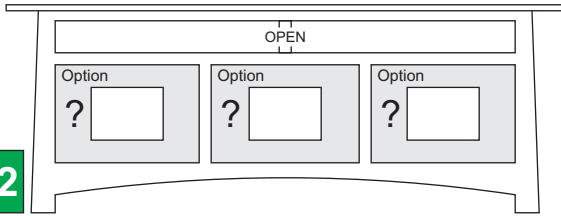

**D**

Wood Door  
w/ 1 adj sh

**G**

Glass Door  
w/ 1 adj sh

**K**

SPK Door  
w/ 1 adj sh

**R**

2 - Drawer

**Wood Selection**

\_\_\_\_\_

**FINISH**

\_\_\_\_\_

**HARDWARE**

DOOR DRAWER

**C3**

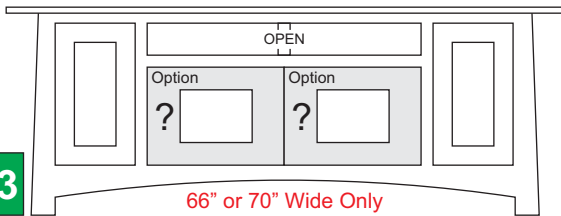

**C4**

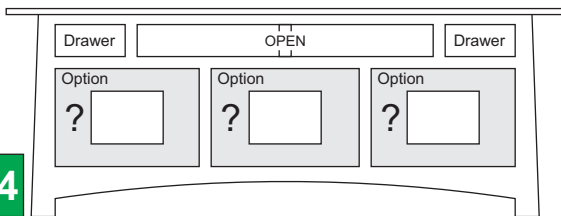

**ADDITIONAL SHELF**

QTY \_\_\_\_\_

# M-[SV]

## SPECIFICATIONS

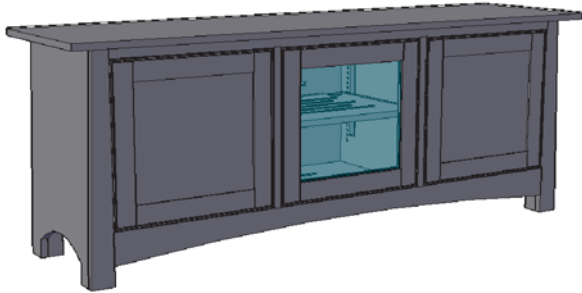

C1

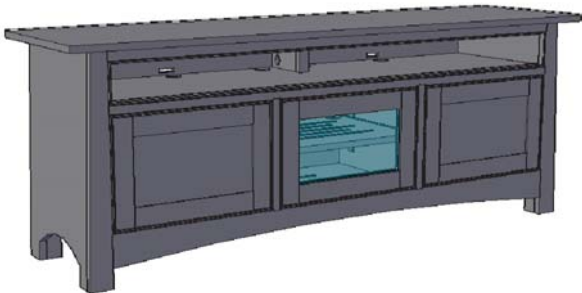

C2

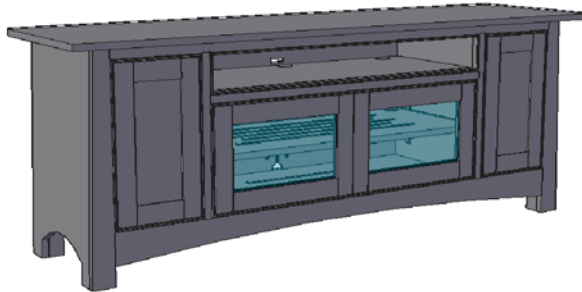

C3

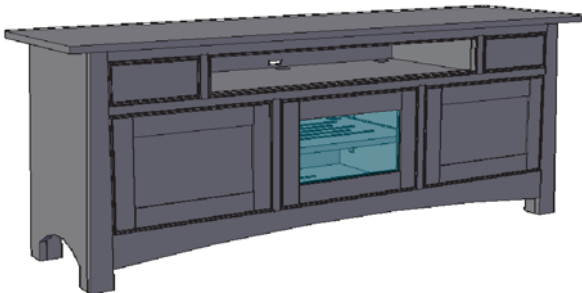

C4

### Featuring:

- Excellent ventilation in the console floor, backs and shelves.
- Smart holes & cut-outs for easy wire management throughout.
- Three prong power harness.
- Adjustable, VENTED shelves.

### Sizing Info

CONSOLE DATA: [SV] [SHORT]			
	UNIT 62	UNIT 66	UNIT 70
Width	62	66	70
Width (OA) (TOP)	65.75	69.75	73.75
Width (OA) BASE-MOLDING (APPROX)	62	66	66
Height	26	26	26
Depth (OA) (TOP)	19	19	19
Depth (OA) BASE-MOLDING (APPROX)	17.5	17.5	17.5
Depth (inside)	16.1875		
[C1] Horz Space (L/R)	17.6875	19	20.3125
[C1] Horz Space (M)	17.625	19	20.375
[C1] Vert Space (Door)	17.5	17.5	17.5
[C1] Vert Space (MSK)	4.83333333	4.83333333	4.83333333
[C1] Drawer Width (inside) (L/R)	15.625	16.9375	18.25
[C1] Drawer Width (inside) (M)	15.5625	16.9375	18.3125
[C1] Drawer Height (inside) (approx)	3	3	3
[C2] Horz Space (L/R)	17.6875	19	20.3125
[C2] Horz Space (M)	17.625	19	20.375
[C2] Vert Space (Door)	12	12	12
[C2] Vert Space (Open/Top)	4	4	4
[C2] Horz Space (Open/Top)	56	60	64
[C2] Drawer Width (inside) (L/R)	15.625	16.9375	18.25
[C2] Drawer Width (inside) (M)	15.5625	16.9375	18.3125
[C2] Drawer Height (inside) (approx)	4	4	4
[C3] Horz Space (SoundBar)		37	37
[C3] Horz Space (media)		37	37
[C3] Horz Space (L/R)		13	15
[C3] Vert Space (SoundBar)		4	4
[C3] Vert Space (media)		12	12
[C3] Vert Space (L/R)		17.5	17.5
[C3] SoundBar Depth		6	6
[C3] Drawer Width (inside)		7.9375	9.9375
[C3] Drawer Height (inside) (approx)		4	4
[C4] Horz Space (L/R)	17.6875	19	20.3125
[C4] Horz Space (M)	17.625	19	20.375
[C4] Vert Space (Door)	12	12	12
[C4] Vert Space (Open/Top)	4	4	4
[C4] Horz Space (Open/Top)	37	37	37
[C4] Drawer Width (inside) (approx)(L/R-top)	5.9375	7.9375	9.9375
[C4] Drawer Height (inside) (approx)(top)	2	2	2
[C4] Drawer Height (inside) (approx)	4	4	4
Drawer Depth (inside)	15	15	15

Upon request, we will change the horizontal values (A & B & C) as well as speaker area sizing for no additional charge.

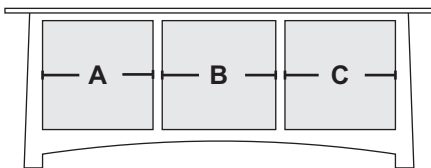

The CONSOLE (width, depth & height) may also be **REDUCED** (gratis) . Further modifications may be requested via quote.

\*Non-Media C1: All Depths -2"

M-(C7-C9)T[SV]

# Sierra Vista (Tall)

CUSTOMER:

DATE:

P.O.

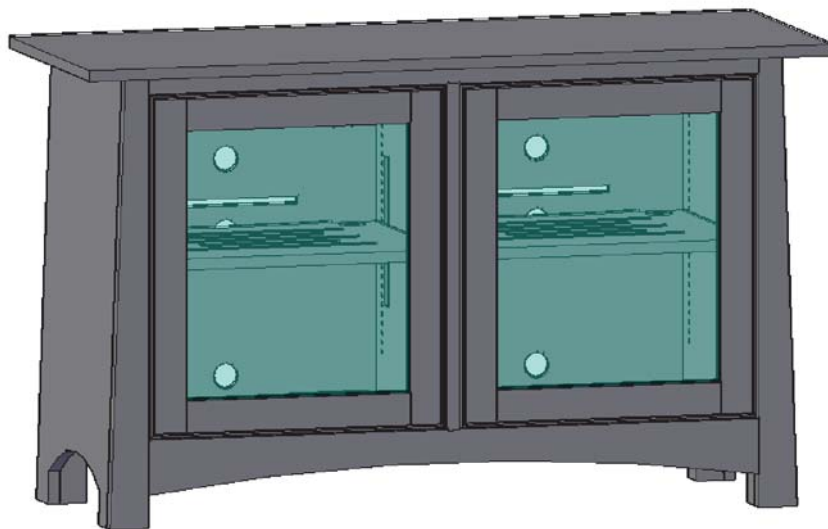

Choose Size

48" M-48T[SV]  
 52" M-52T[SV]

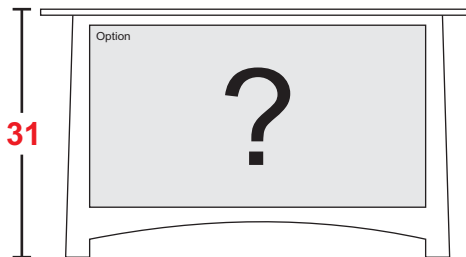

**C7**

Non Media Cabinet

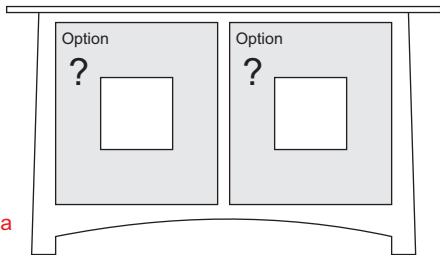

Option Selections:

(Write selection on WHITE / GREY boxes)

<b>D</b>	<b>G</b>	<b>K</b>	<b>R</b>	<b>M</b>
Wood Door w/ 1 adj sh	Glass Door w/ 1 adj sh	SPK Door w/ 1 adj sh	2 - Drawer	1 - Drawer w/ SPK Drop-Door

Option Selections:

Write selection on WHITE/GREY boxes

**C8**

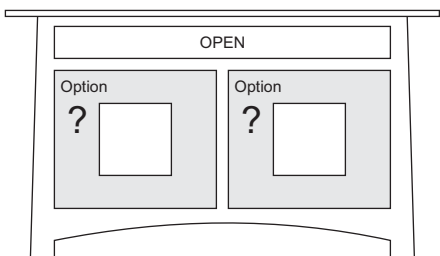

**D**

Wood Door  
w/ 1 adj sh

**G**

Glass Door  
w/ 1 adj sh

**K**

SPK Door  
w/ 1 adj sh

**R**

2 - Drawer

Wood Selection

FINISH

HARDWARE

DOOR DRAWER

**C9**

Non Media Cabinet

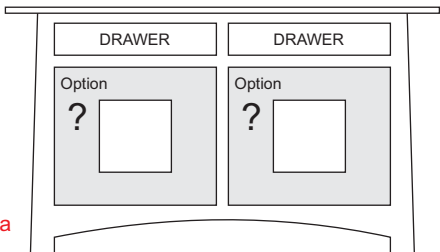

QTY  
**ADDITIONAL SHELF**

# M-T[SV]

## SPECIFICATIONS

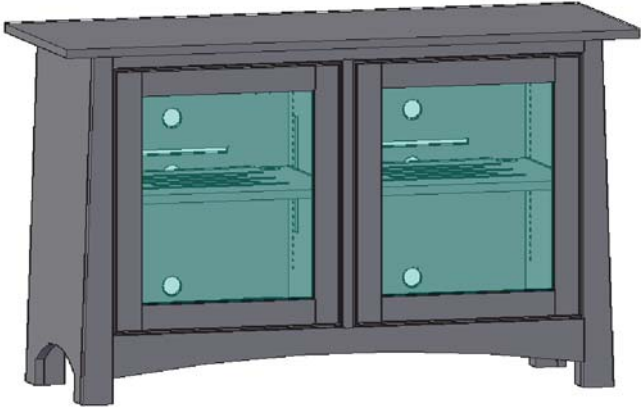

C7

### Featuring:

- Excellent ventilation in the console floor, backs and shelves.
- Smart holes & cut-outs for easy wire management throughout.
- Three prong power harness.
- Adjustable, VENTED shelves.

Upon request, we will change the horizontal values (A & B) as well as speaker area sizing for no additional charge.

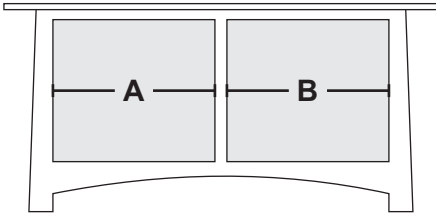

The **CONSOLE** (width, depth & height) may also be **REDUCED** (gratis) .  
Further modifications may be requested via quote.

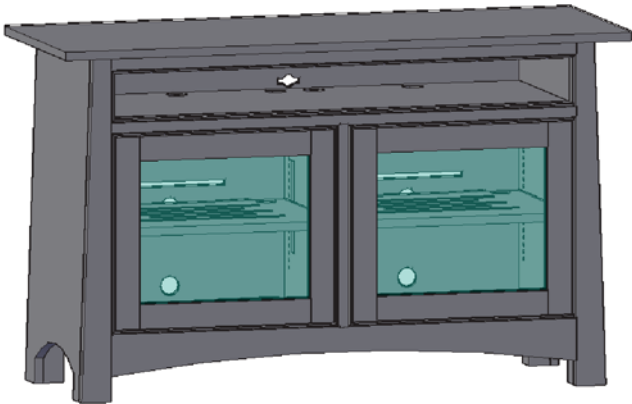

C8

### Sizing Info

#### CONSOLE DATA: [SV] [TALL]

	UNIT 48	UNIT 52
Width	48	52
Width (OA) (TOP)	50.25	54.25
Width (OA) BASE-MOLDING (APPROX)	50	54
Height	31	31
Depth (OA) (TOP)	19	19
Depth (OA) BASE-MOLDING (APPROX)	17.5	17.5
Depth (inside)	16.5	
[C7] Horz Space (L/R)	20.25	22.25
[C7] Vert Space (Door)	22.5	22.5
[C7] Drawer Width (inside) (L/R)	18.1875	20.1875
[C8] Horz Space (L/R)	20.25	22.25
[C8] Vert Space (Door)	17	17
[C8] Horz Space (Soundbar)	42	46
[C8] Vert Space (Soundbar)	4	4
[C9] Horz Space (L/R)	20.25	22.25
[C9] Vert Space (Door)	17	17
[C9] Horz Space (Drawer)	20.25	22.25
[C9] Vert Space (Drawer)	4	4
[C9] Drawer Width (inside) (approx)	19.4375	21.4375
[C9] Drawer Height (inside) (approx)	2	2
Drawer Depth (inside)	15	15

\*Non-Media C7 & C9: All Depths -2"



C9

**M-(C7-C9)[SV]**

# Sierra Vista

(Short)

CUSTOMER:

DATE: P.O.

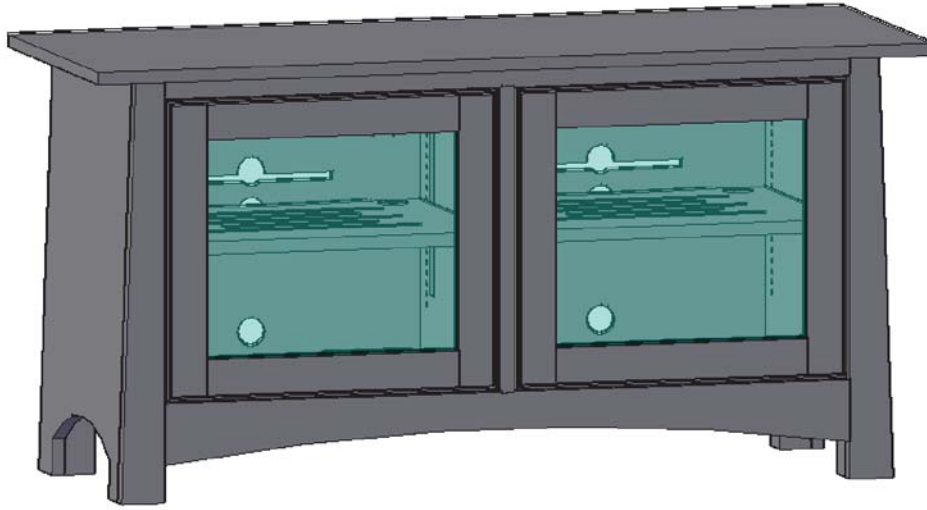

Choose Size

48" M-48[SV]
  52" M-52[SV]

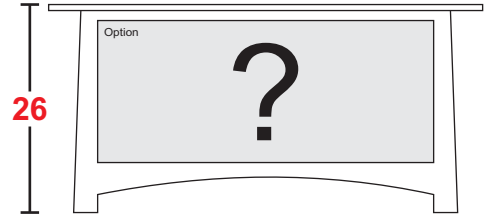

**C7**

Non Media Cabinet

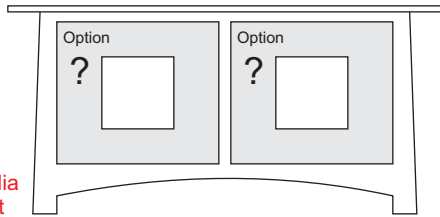

Option Selections:

(Write selection on WHITE / GREY boxes)

<b>D</b>	<b>G</b>	<b>K</b>	<b>R</b>	<b>M</b>
Wood Door w/ 1 adj sh	Glass Door w/ 1 adj sh	SPK Door w/ 1 adj sh	2 - Drawer	1 - Drawer w/ SPK Drop-Door

Option Selections:

Write selection on WHITE/GREY boxes

**C8**

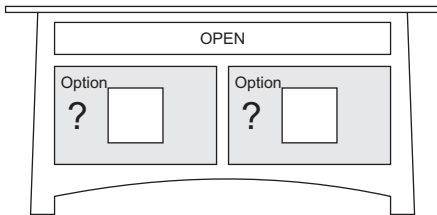

Wood Door  
w/ 1 adj sh



Glass Door  
w/ 1 adj sh

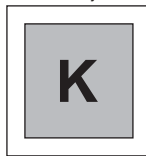

SPK Door  
w/ 1 adj sh

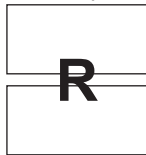

2 - Drawer

Wood Selection

FINISH

HARDWARE

DOOR DRAWER

**C9**

Non Media Cabinet

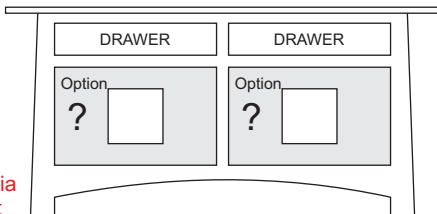

2 - Drawer

QTY
 **ADDITIONAL SHELF**



# M-[SV]

## SPECIFICATIONS

### Featuring:

- Excellent ventilation in the console floor, backs and shelves.
- Smart holes & cut-outs for easy wire management throughout.
- Three prong power harness.
- Adjustable, VENTED shelves.

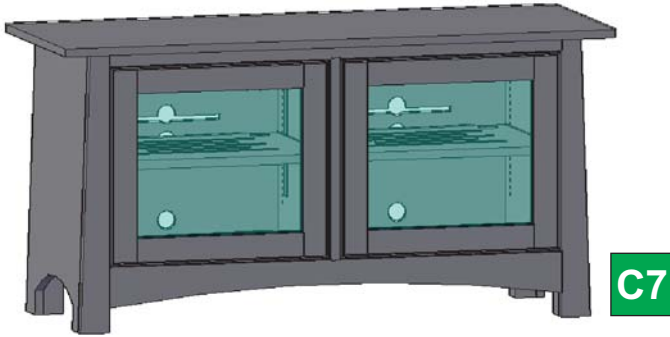

C7

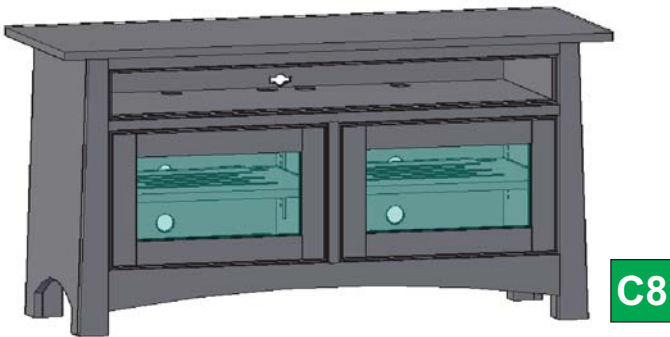

C8



C9

Upon request, we will change the horizontal values (A & B) as well as speaker area sizing for no additional charge.

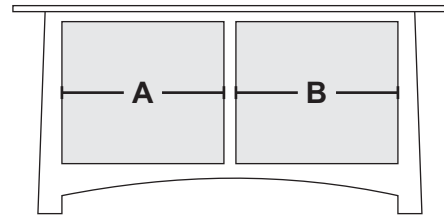

The **CONSOLE** (width, depth & height) may also be **REDUCED** (gratis) .  
Further modifications may be requested via quote.

### Sizing Info

CONSOLE DATA: [SV] [SHORT]		
	UNIT 48	UNIT 52
Width	48	52
Width (OA) (TOP)	50.25	54.25
Width (OA) BASE-MOLDING (APPROX)	50	54
Height	26	26
Depth (OA) (TOP)	19	19
Depth (OA) BASE-MOLDING (APPROX)	17.5	17.5
Depth (inside)	16.5	
[C7] Horz Space (L/R)	20.25	22.25
[C7] Vert Space (Door)	17.5	17.5
[C7] Drawer Width (inside) (L/R)	18.1875	20.1875
[C8] Horz Space (L/R)	20.25	22.25
[C8] Vert Space (Door)	12	12
[C8] Horz Space (Soundbar)	42	46
[C8] Vert Space (Soundbar)	4	4
[C9] Horz Space (L/R)	20.25	22.25
[C9] Vert Space (Door)	12	12
[C9] Horz Space (Drawer)	20.25	22.25
[C9] Vert Space (Drawer)	4	4
[C9] Drawer Width (inside) (approx)	19.4375	21.4375
[C9] Drawer Height (inside) (approx)	2	2
Drawer Depth (inside)	15	15

\*Non-Media C7 & C9: All Depths -2"



# GB-(C1-C4)T[SV]

# Sierra Vista

CUSTOMER:

DATE:

P.O.

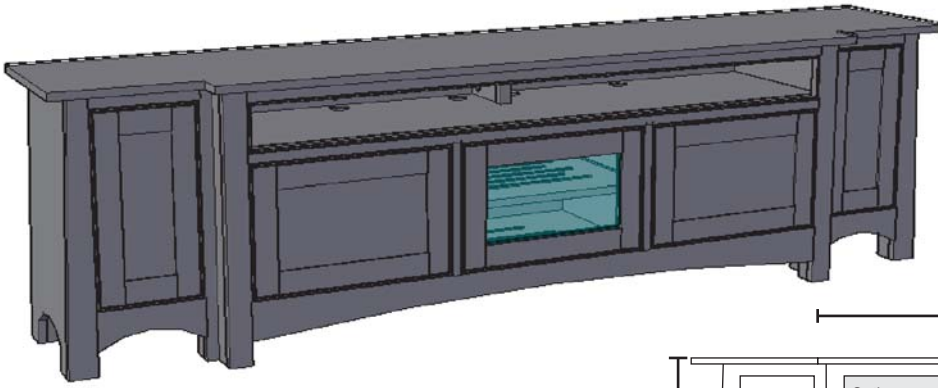

62" GB-62T[SV]

66" GB-66T[SV]

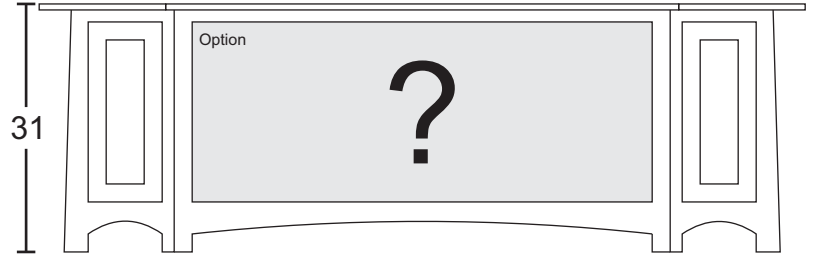

**Option Selections:**

(Write selection on WHITE / GREY boxes)

**C1**

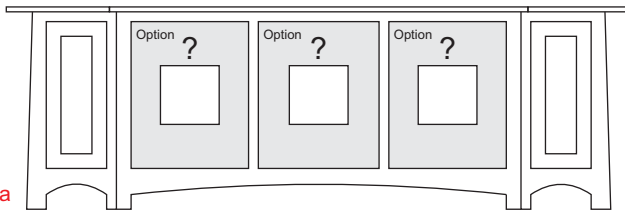

Non Media Cabinet

<b>D</b>	<b>G</b>	<b>K</b>	<b>R</b>	<b>M</b>
Wood Door w/ 1 adj sh	Glass Door w/ 1 adj sh	SPK Door w/ 1 adj sh	2 - Drawer	1 - Drawer w/ SPK Drop-Door

**C2**

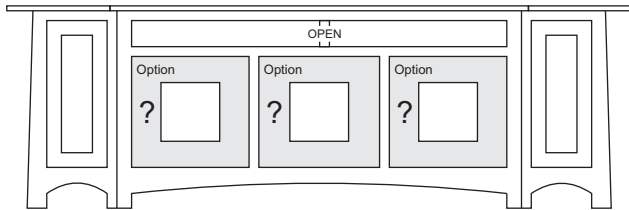

**Option Selections:**

Write selection on WHITE/GREY boxes

**D**

Wood Door  
w/ 1 adj sh

**G**

Glass Door  
w/ 1 adj sh

**K**

SPK Door  
w/ 1 adj sh

**R**

2 - Drawer

**Wood Selection**

**FINISH**

**HARDWARE**

<input type="text"/>	<input type="text"/>
----------------------	----------------------

DOOR DRAWER

**ADDITIONAL SHELF**

QTY

**C3**

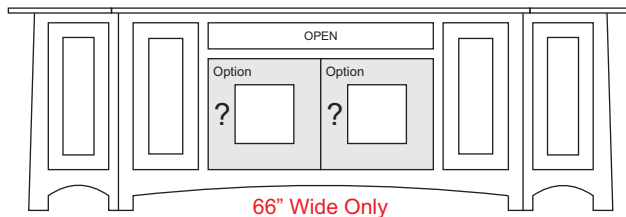

66" Wide Only

**C4**

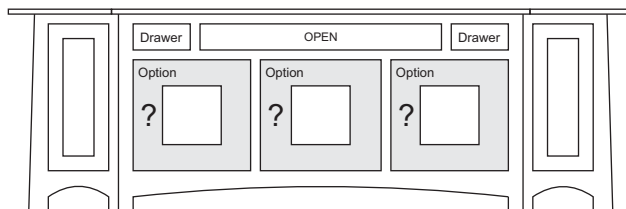

# GB-(C1-C4)T[SV]

## SPECIFICATIONS

### Featuring:

- Excellent ventilation in the console floor, backs and shelves.
- Smart holes & cut-outs for easy wire management throughout.
- Three prong power harness.
- Adjustable, VENTED shelves.

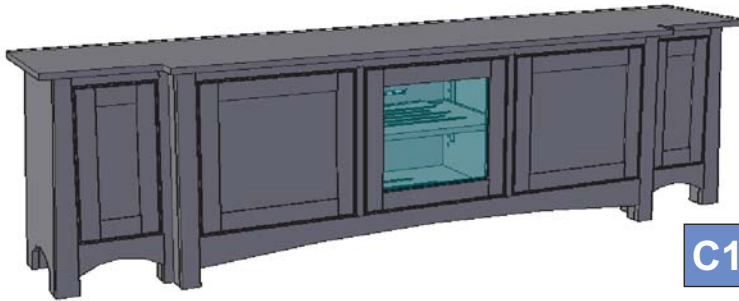

C1

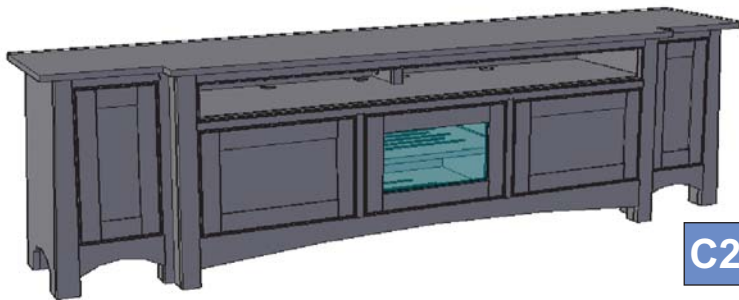

C2

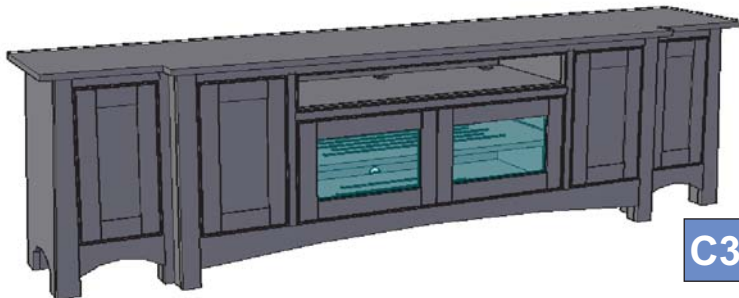

C3

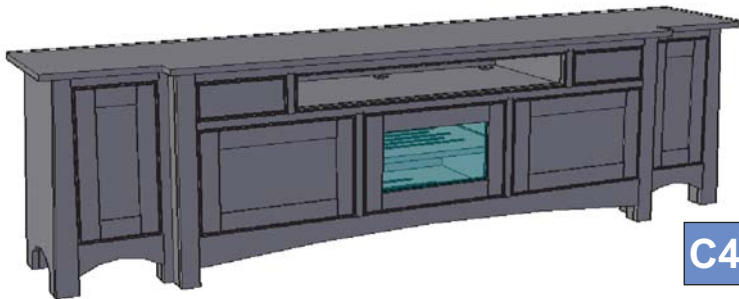

C4

Upon request, we will change the horizontal values (A & B & C) as well as speaker area sizing for no additional charge.

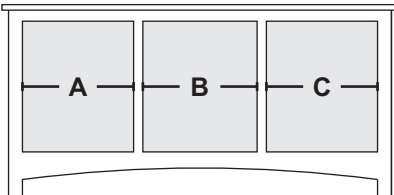

The **CONSOLE & BOOKCASE** (width, depth & height) may also be **REDUCED** (gratis) . Further modifications may be requested via quote.

### Sizing Info

	CONSOLE Width	OA Box Width	OA Width (w/ Crown)
UNIT 62	62	89.5	93.25
UNIT 66	66	93.5	97.25
<b>CONSOLE DATA: [SV] [TALL]</b>			
	<b>UNIT 62</b>	<b>UNIT 66</b>	
Width	62	66	
Width (OA) (TOP)	65.75	69.75	
Width (OA) BASE-MOLDING (APPROX)	62	66	
Height	31	31	
Depth (OA) (TOP)	19	19	
Depth (OA) BASE-MOLDING (APPROX)	17.5	17.5	
Depth (inside)	16.5		
[C1] Horz Space (L/R)	17.6875	19	
[C1] Horz Space (M)	17.625	19	
[C1] Vert Space (Door)	22.5	22.5	
[C1] Vert Space (MSK)	6.5	6.5	
[C1] Drawer Width (inside) (L/R)	15.625	16.9375	
[C1] Drawer Width (inside) (M)	15.5625	16.9375	
[C1] Drawer Height (inside) (approx)	5	5	
[C2] Horz Space (L/R)	17.6875	19	
[C2] Horz Space (M)	17.625	19	
[C2] Vert Space (Door)	17	17	
[C2] Vert Space (Open/Top)	4	4	
[C2] Horz Space (Open/Top)	56	60	
[C2] Drawer Width (inside) (L/R)	15.625	16.9375	
[C2] Drawer Width (inside) (M)	15.5625	16.9375	
[C2] Drawer Height (inside) (approx)	6	6	
[C3] Horz Space (SoundBar)		37	
[C3] Horz Space (media)		37	
[C3] Horz Space (L/R)		13	
[C3] Vert Space (SoundBar)		4	
[C3] Vert Space (media)		17	
[C3] Vert Space (L/R)		22.5	
[C3] SoundBar Depth		6	
[C3] Drawer Width (inside)		7.9375	
[C3] Drawer Height (inside) (approx)		6	
[C4] Horz Space (L/R)	17.6875	19	
[C4] Horz Space (M)	17.625	19	
[C4] Vert Space (Door)	17	17	
[C4] Vert Space (Open/Top)	4	4	
[C4] Horz Space (Open/Top)	37	37	
[C4] Drawer Width (inside) (approx)(L/R-top)	5.9375	7.9375	
[C4] Drawer Height (inside) (approx)(top)	2	2	
[C4] Drawer Height (inside) (approx)	6	6	
Drawer Depth (inside)	15	15	
<b>B_BOOKCASE DATA</b>			
Bookcase Width	13.75	13.75	
Bookcase Depth	14.5	14.5	
Bookcase Depth (inside)	11.75	11.75	
Bookcase Height	31	31	
Bookcase Vert Space	22.5	22.5	
Bookcase Horz Space	9.25	9.25	

\*Non-Media C1: All Depths -2"

**GA-T[SV]**

# Sierra Vista (Tall)

CUSTOMER:

DATE:

P.O.

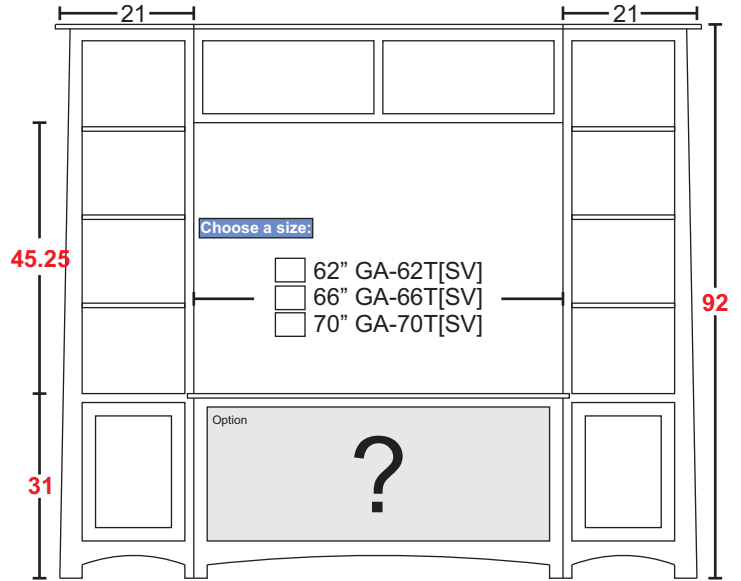

**C1**

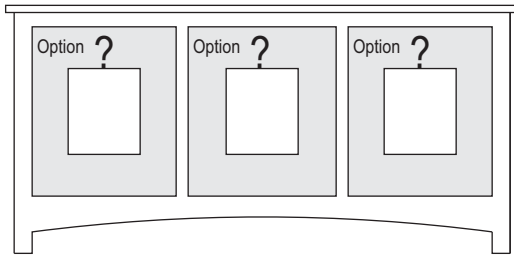

**Option Selections:**

(Write selection on WHITE / GREY boxes)

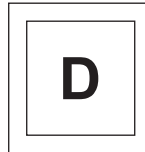

**D**

Wood Door  
w/ 1 adj sh



**G**

Glass Door  
w/ 1 adj sh

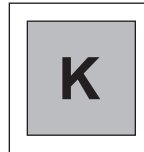

**K**

SPK Door  
w/ 1 adj sh

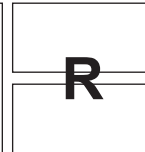

**R**

2 - Drawer

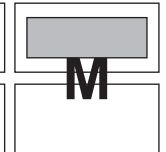

**M**

1 - Drawer  
w/ SPK Drop-Door

**C2**

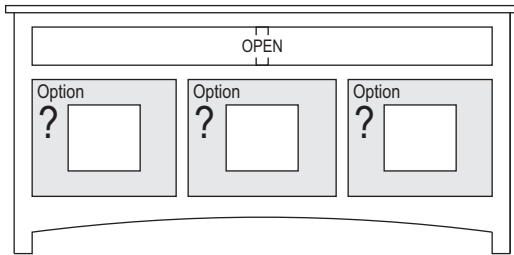

**Option Selections:**

Write selection on  
WHITE/GREY boxes

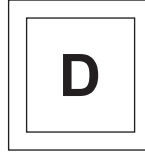

**D**

Wood Door  
w/ 1 adj sh



**G**

Glass Door  
w/ 1 adj sh

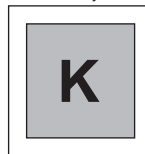

**K**

SPK Door  
w/ 1 adj sh

**C3**

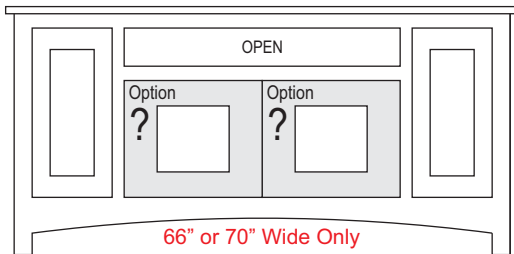

**R**

2 - Drawer

**C4**

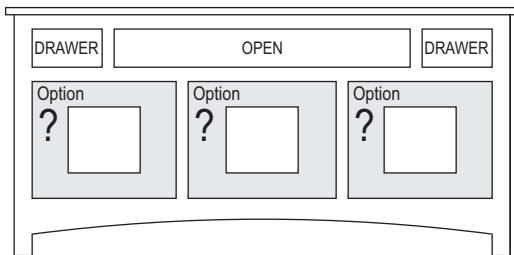

**Wood Selection**

**FINISH**

**HARDWARE**

**DOOR DRAWER**

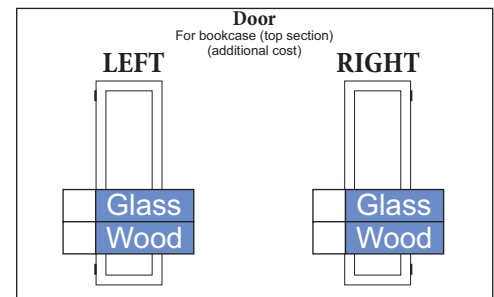

**LED Lights**

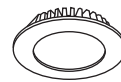

**QTY**

**Additional Wood Shelves**

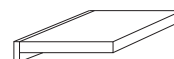

**QTY**

**Glass Shelves**  
(Specify location / QTY)

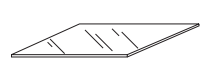

**QTY**

**NOTE:**

Upon request, we will change the vertical values (X & Y) as well as the horizontal values (A & B & C) for no additional charge.

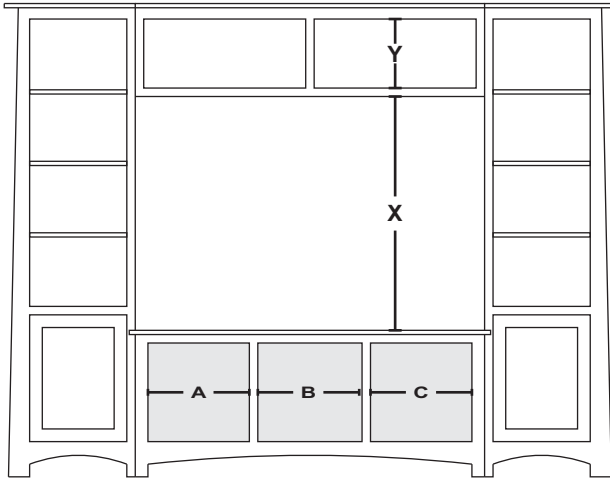

The **CONSOLE & BOOKCASE** (width, depth & height) may also be **REDUCED**.  
**Example:** if a 64" console is needed, order the 66" unit and request the modification at no additional cost. Further modifications may be requested via quote.

**Featuring:**

- Excellent ventilation in the console backs and shelves.
- Smart holes & cut-outs for easy wire management throughout.
- Three prong power harness.
- Adjustable shelves.
- Unique cut-out in console top and trim, returning to the piers.
- Lighting (upon request).

**Common Questions:**

- How wide should my console be in relation to my TV?
  - Keep in mind, most manufacturers require 4" all around the TV for heat diffusion.
- Can I hang my TV on the console upper?
  - Yes! The back panel of the upper is very sturdy, and locks into the bookcases as well as the console for a secure means of hanging.
- Can I order this system to fit into an alcove?
  - Possibly. Send in a quote request. Be aware that most clients will require some finish carpentry to complete the job to satisfaction.

**Sizing Info**

	CONSOLE Width	OA Box Width	OA Width (w/ Crown)
UNIT 62	62	104	109.5
UNIT 66	66	108	113.5
UNIT 70	70	112	117.5
<b>CONSOLE DATA: [SV] [TALL]</b>			
	UNIT 62	UNIT 66	UNIT 70
Width	62	66	70
Width (OA) (TOP)	65.75	69.75	73.75
Width (OA) BASE-MOLDING (APPROX)	62	66	66
Height	31	31	31
Depth (OA) (TOP)	19	19	19
Depth (OA) BASE-MOLDING (APPROX)	17.5	17.5	17.5
Depth (inside)	16.5		
[C1] Horz Space (L/R)	17.6875	19	20.3125
[C1] Horz Space (M)	17.625	19	20.375
[C1] Vert Space (Door)	22.5	22.5	22.5
[C1] Vert Space (MSK)	6.5	6.5	6.5
[C1] Drawer Width (inside) (L/R)	15.625	16.9375	18.25
[C1] Drawer Width (inside) (M)	15.5625	16.9375	18.3125
[C1] Drawer Height (inside) (approx)	5	5	5
[C2] Horz Space (L/R)	17.6875	19	20.3125
[C2] Horz Space (M)	17.625	19	20.375
[C2] Vert Space (Door)	17	17	17
[C2] Vert Space (Open/Top)	4	4	4
[C2] Horz Space (Open/Top)	56	60	64
[C2] Drawer Width (inside) (L/R)	15.625	16.9375	18.25
[C2] Drawer Width (inside) (M)	15.5625	16.9375	18.3125
[C2] Drawer Height (inside) (approx)	6	6	6
[C3] Horz Space (SoundBar)		37	37
[C3] Horz Space (media)		37	37
[C3] Horz Space (L/R)		13	15
[C3] Vert Space (SoundBar)		4	4
[C3] Vert Space (media)		17	17
[C3] Vert Space (L/R)		22.5	22.5
[C3] SoundBar Depth		6	6
[C3] Drawer Width (inside)		7.9375	9.9375
[C3] Drawer Height (inside) (approx)		6	6
[C4] Horz Space (L/R)	17.6875	19	20.3125
[C4] Horz Space (M)	17.625	19	20.375
[C4] Vert Space (Door)	17	17	17
[C4] Vert Space (Open/Top)	4	4	4
[C4] Horz Space (Open/Top)	37	37	37
[C4] Drawer Width (inside) (approx)(L/R-top)	5.9375	7.9375	9.9375
[C4] Drawer Height (inside) (approx)(top)	2	2	2
[C4] Drawer Height (inside) (approx)	6	6	6
Drawer Depth (inside)	15	15	15
<b>UPPER DATA</b>			
	UNIT 62	UNIT 66	UNIT 70
Width	62	66	70
Height	61	61	61
Depth (OA)	12.75	12.75	12.75
Depth (inside)(top)	11.75	11.75	11.75
Vert Space Cubbie	11.25	11.25	11.25
TV Space Horz	62	66	70
Top Space Horz	30.25	32.25	34.25
TV Space Vert	45.4375		
TOP Space Vert	11.25	11.25	11.25
<b>BOOKCASE DATA</b>			
Bookcase Width	21	21	21
Bookcase Depth	12.75	12.75	12.75
Bookcase Depth (inside)	11.75	11.75	11.75
Bookcase Height	92	92	92
Bookcase Vert Space (Top)	59	59	59
Bookcase Vert Space (Bot)	23.25	23.25	23.25
Bookcase Horz Space (FF)	15.5	15.5	15.5
Bookcase Horz Space (Gut)	15.5	15.5	15.5

**GA-[SV]**

# Sierra Vista

(Short)

CUSTOMER:

DATE:

P.O.

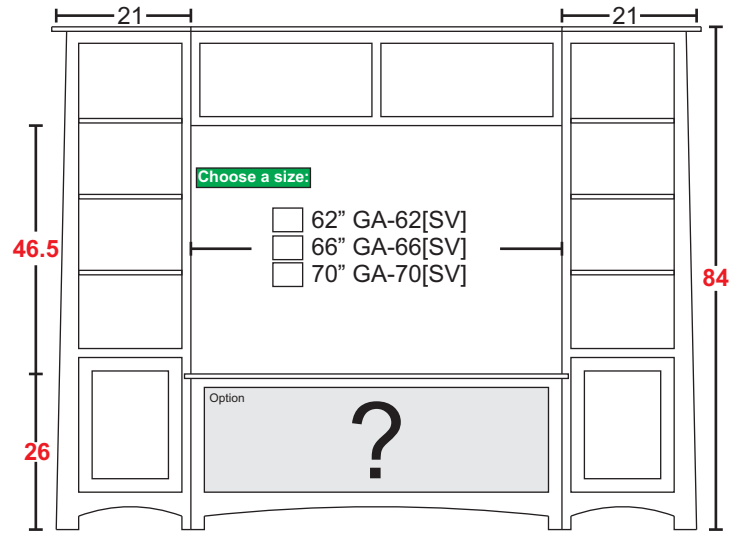

**Option Selections:**

(Write selection on WHITE / GREY boxes)

**C1**

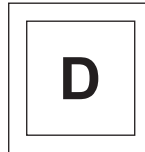
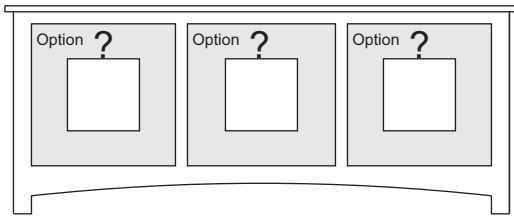

Wood Door  
w/ 1 adj sh



Glass Door  
w/ 1 adj sh

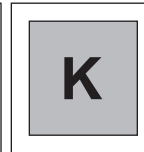

SPK Door  
w/ 1 adj sh

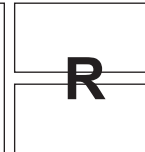

2 - Drawer

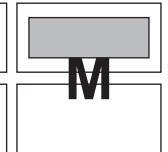

1 - Drawer  
w/ SPK Drop-Door

**C2**

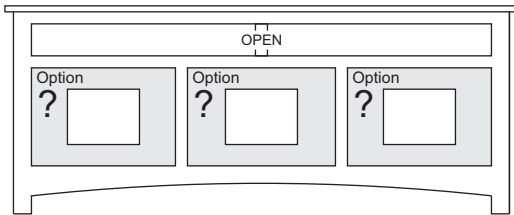

**Option Selections:**

Write selection on  
WHITE/GREY boxes

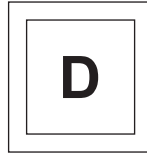

Wood Door  
w/ 1 adj sh



Glass Door  
w/ 1 adj sh

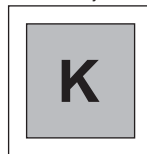

SPK Door  
w/ 1 adj sh

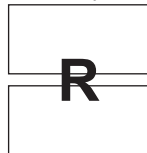

2 - Drawer

**C3**

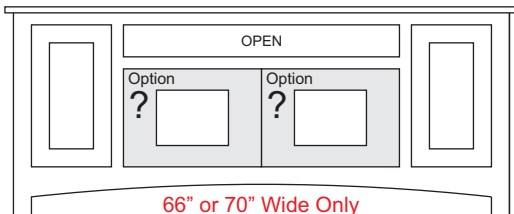

**C4**

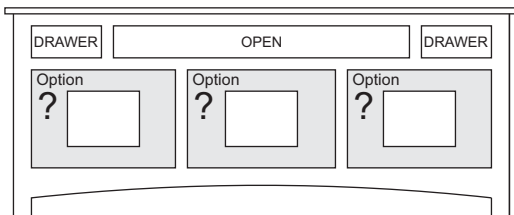

**Wood Selection**

**FINISH**

**HARDWARE**

**DOOR DRAWER**

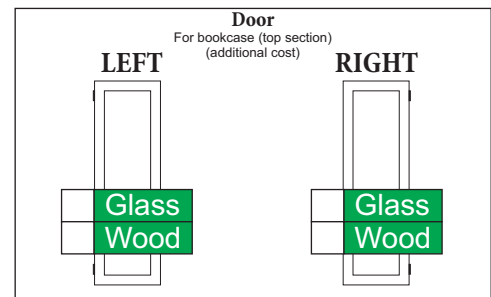

**LED Lights**

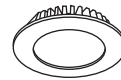

QTY

**Additional Wood Shelves**

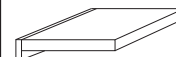

QTY

**Glass Shelves**  
(Specify location / QTY)

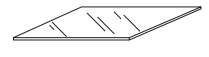

QTY

**NOTE:**

Upon request, we will change the vertical values (X & Y) as well as the horizontal values (A & B & C) for no additional charge.

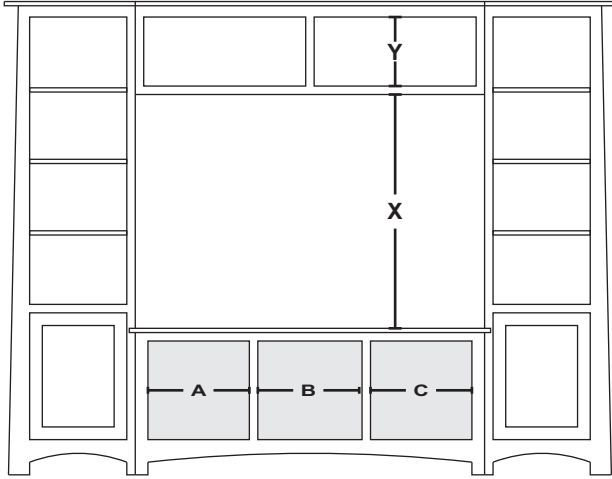

The **CONSOLE & BOOKCASE** (width, depth & height) may also be **REDUCED**.  
**Example:** if a 64" console is needed, order the 66" unit and request the modification at no additional cost. Further modifications may be requested via quote.

**Featuring:**

- Excellent ventilation in the console backs and shelves.
- Smart holes & cut-outs for easy wire management throughout.
- Three prong power harness.
- Adjustable shelves.
- Unique cut-out in console top and trim, returning to the piers.
- Lighting (upon request).

**Common Questions:**

- How wide should my console be in relation to my TV?
  - Keep in mind, most manufacturers require 4" all around the TV for heat diffusion.
- Can I hang my TV on the console upper?
  - Yes! The back panel of the upper is very sturdy, and locks into the bookcases as well as the console for a secure means of hanging.
- Can I order this system to fit into an alcove?
  - Possibly. Send in a quote request. Be aware that most clients will require some finish carpentry to complete the job to satisfaction.

**Sizing Info**

CONSOLE DATA: [SV] [SHORT]			
	UNIT 62	UNIT 66	UNIT 70
Width	62	66	70
Width (OA) (TOP)	65.75	69.75	73.75
Width (OA) BASE-MOLDING (APPROX)	62	66	66
Height	26	26	26
Depth (OA) (TOP)	19	19	19
Depth (OA) BASE-MOLDING (APPROX)	17.5	17.5	17.5
Depth (inside)	16.5		
[C1] Horz Space (L/R)	17.6875	19	20.3125
[C1] Horz Space (M)	17.625	19	20.375
[C1] Vert Space (Door)	17.5	17.5	17.5
[C1] Vert Space (MSK)	4.83333333	4.83333333	4.83333333
[C1] Drawer Width (inside) (L/R)	15.625	16.9375	18.25
[C1] Drawer Width (inside) (M)	15.5625	16.9375	18.3125
[C1] Drawer Height (inside) (approx)	3	3	3
[C2] Horz Space (L/R)	17.6875	19	20.3125
[C2] Horz Space (M)	17.625	19	20.375
[C2] Vert Space (Door)	12	12	12
[C2] Vert Space (Open/Top)	4	4	4
[C2] Horz Space (Open/Top)	56	60	64
[C2] Drawer Width (inside) (L/R)	15.625	16.9375	18.25
[C2] Drawer Width (inside) (M)	15.5625	16.9375	18.3125
[C2] Drawer Height (inside) (approx)	4	4	4
[C3] Horz Space (SoundBar)		37	37
[C3] Horz Space (media)		37	37
[C3] Horz Space (L/R)		13	15
[C3] Vert Space (SoundBar)		4	4
[C3] Vert Space (media)		12	12
[C3] Vert Space (L/R)		17.5	17.5
[C3] SoundBar Depth		6	6
[C3] Drawer Width (inside)		7.9375	9.9375
[C3] Drawer Height (inside) (approx)		4	4
[C4] Horz Space (L/R)	17.6875	19	20.3125
[C4] Horz Space (M)	17.625	19	20.375
[C4] Vert Space (Door)	12	12	12
[C4] Vert Space (Open/Top)	4	4	4
[C4] Horz Space (Open/Top)	37	37	37
[C4] Drawer Width (inside) (approx)(L/R-top)	5.9375	7.9375	9.9375
[C4] Drawer Height (inside) (approx)(top)	2	2	2
[C4] Drawer Height (inside) (approx)	4	4	4
Drawer Depth (inside)	15	15	15
<b>UPPER DATA</b>			
	UNIT 62	UNIT 66	UNIT 70
Width	62	66	70
Height	58	58	58
Depth (OA)	12.75	12.75	12.75
Depth (inside)(top)	11.75	11.75	11.75
Vert Space Cubbie	11.25	11.25	11.25
TV Space Horz	62	66	70
Top Space Horz	30.25	32.25	34.25
TV Space Vert	42.4375		
TOP Space Vert	11.25	11.25	11.25
<b>BOOKCASE DATA</b>			
	UNIT 62	UNIT 66	UNIT 70
Bookcase Width	21	21	21
Bookcase Depth	12.75	12.75	12.75
Bookcase Depth (inside)	11.75	11.75	11.75
Bookcase Height	84	84	84
Bookcase Vert Space (Top)	51	51	51
Bookcase Vert Space (Bot)	23.25	23.25	23.25
Bookcase Horz Space (FF)	15.5	15.5	15.5
Bookcase Horz Space (Gut)	15.5	15.5	15.5